

Hur stor är volymen? (I)

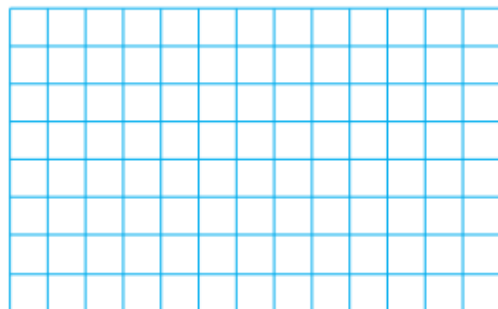

3

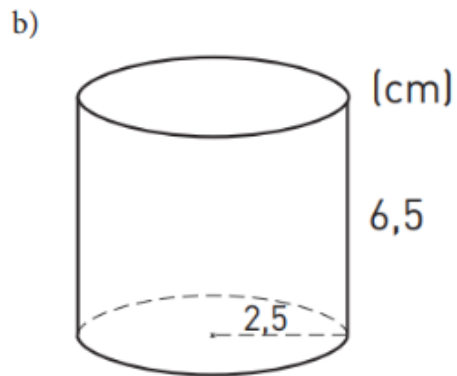

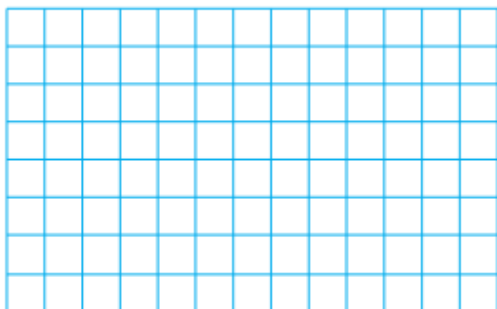
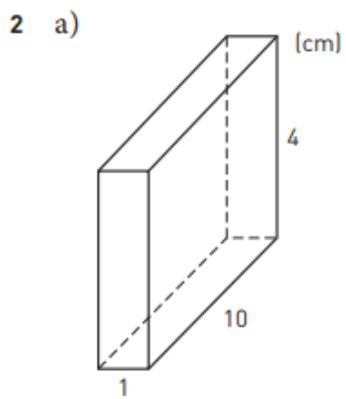
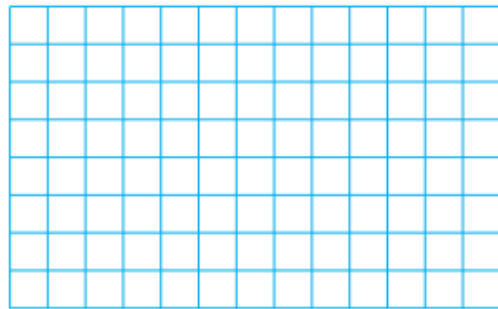
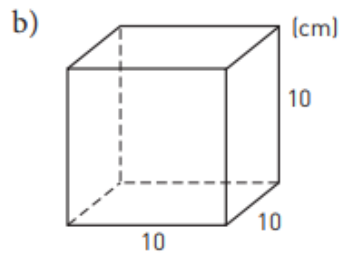
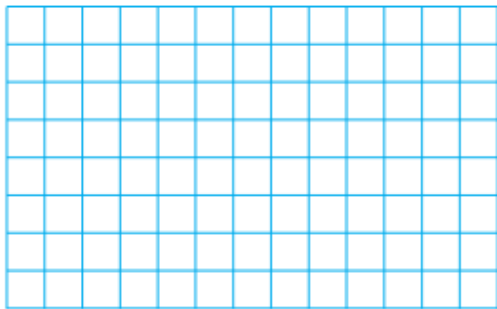
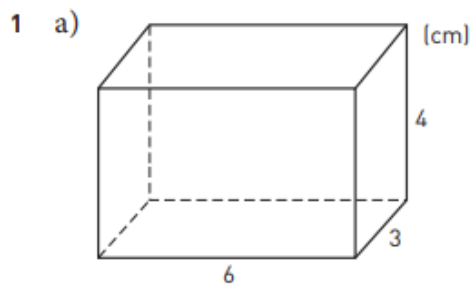
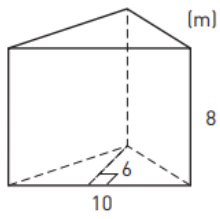
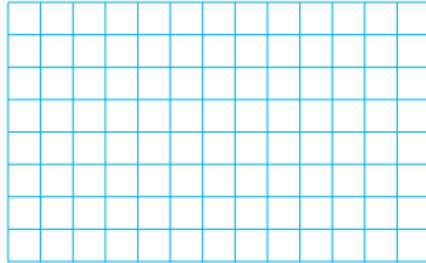
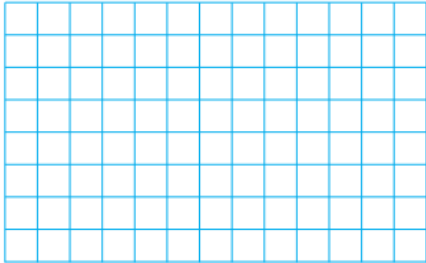

4

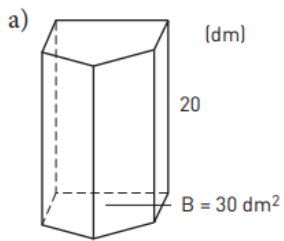

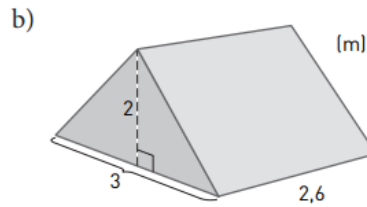
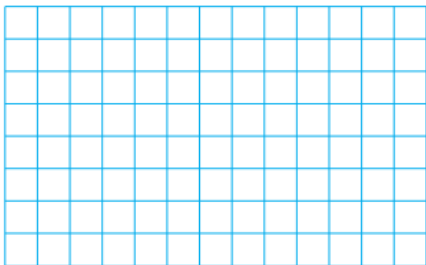

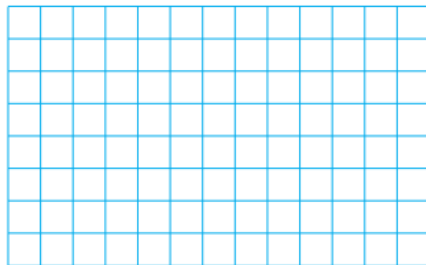

5.

a) Hur många kubikcentimeter rymmer kastrullen?

Avrunda till hundratal. _____

b) Hur stor är volymen i milliliter? _____

c) Skriv volymen i liter. _____

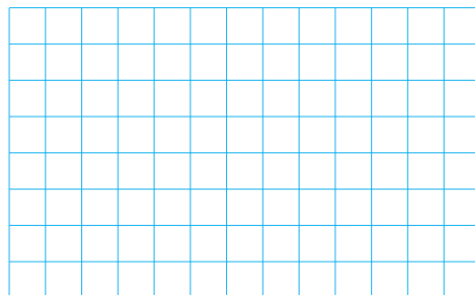
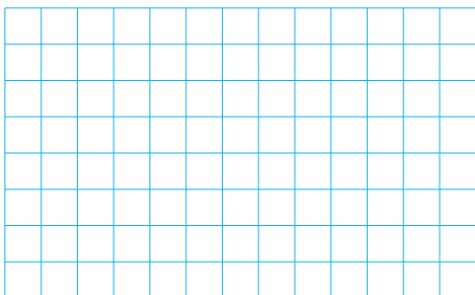
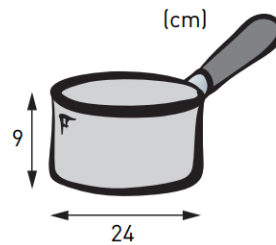

Facit

1. a) 72 cm^3 b) 1000 cm^3

2. a) 40 cm^3 b) 128 m^3

3. 240 m^3

4. a) 600 dm^3 b) $7,8 \text{ m}^3$

5. a) 4100 cm^3 b) 4100 ml c) $4,1 \text{ liter}$